

IsoBlock I-FG

Single-Channel FluxGate
Current Measuring Module

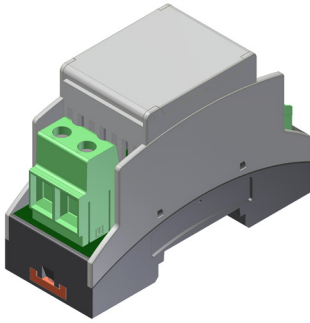

OVERVIEW

The IsoBlock Current-FG is a sensor designed for high-quality isolated current measurements in the range from 6 to 50 Amperes. The IsoBlock Current-FG module provides 1200V primary-to-secondary isolation, which allows users to monitor a miscellaneous of currents at different potentials. The IsoBlock Current-FG uses Flux-Gate methodology to measure the current flowing through the input conductor. In essence, this technique works by placing a toroid with a high number of turns (secondary) around the input current path (primary), while a close-loop circuitry controls the current through the secondary to null out the magnetic field inside the toroid. The input current is then obtained by multiplying the current from the control circuitry by the number of turns of the secondary. This is followed by an anti-aliasing filter and a conditioning stage to output a $\pm 10V$ signal.

The compact form factor of the IsoBlock Current-FG module allows users to setup high channel density monitoring systems, making it ideal for deployed and portable systems.

SPECIFICATION

IsoBlock I-FG	6A	15A	25A	50A
Bandwidth (-3dB point)	DC - 300kHz			
Integrated sensor noise (Referenced to input)	< 3.2 mA	< 6 mA	< 10 mA	< 18 mA
Conversion Factor	1.667 V/A	666.667 mV/A	400 mV/A	200 mV/A
Input dynamic range	12A	30A	50A	100A

HARDWARE DESCRIPTION

The current input connector is located at the top of the module in the figure above. A connector that serves to power the unit and output the sensor signal lays along the bottom.

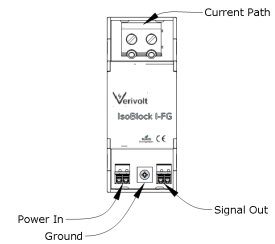

indication of input, output and power of the IsoBlock I-FG

The IsoBlock Current module is designed to mount on standard NS-35 or NS-32 DIN rails with minimal preparation, providing users ease of use and flexibility.

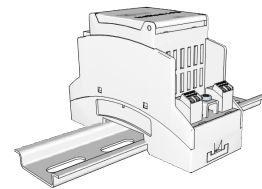

Installation on DIN rail

Electrical	
Accuracy (percentage of reading)	$\pm 0.2\%$
Max total phase shift at 60Hz	< 0.05°
Max Input delay	< $5 \mu s$
Isolation voltage from primary side to secondary side	> $\pm 1200V$
Withstanding common mode surge voltage	$\pm 2000V$
Thermal drift gain	< $\pm 0.01\% / ^\circ C$
Mechanical	
Mounting Type	DIN Rail
Outer Dimensions	3.5" x 2.5" x 1.5"
Weight	205 g (7.2 oz)

Performance	
Input-Output non-linearity	< 280 ppm/A
Output voltage	$\pm 10V, \pm 5V$ Custom
Gain temperature drift	± 50 ppm/ $^\circ C$
Power Supply Voltage	8V to 28V
Output type	Differential signal
Output Offset Voltage	< $\pm 500 \mu V$
Output impedance	100 Ω
Common mode impedance	> 2 G Ω 4pF
Differential Input impedance	> 1 M Ω
Environmental	
Operating temperature	- 25 to 65 $^\circ C$
Storage temperature	- 40 to 70 $^\circ C$

MERCHICAL DIMENSIONS

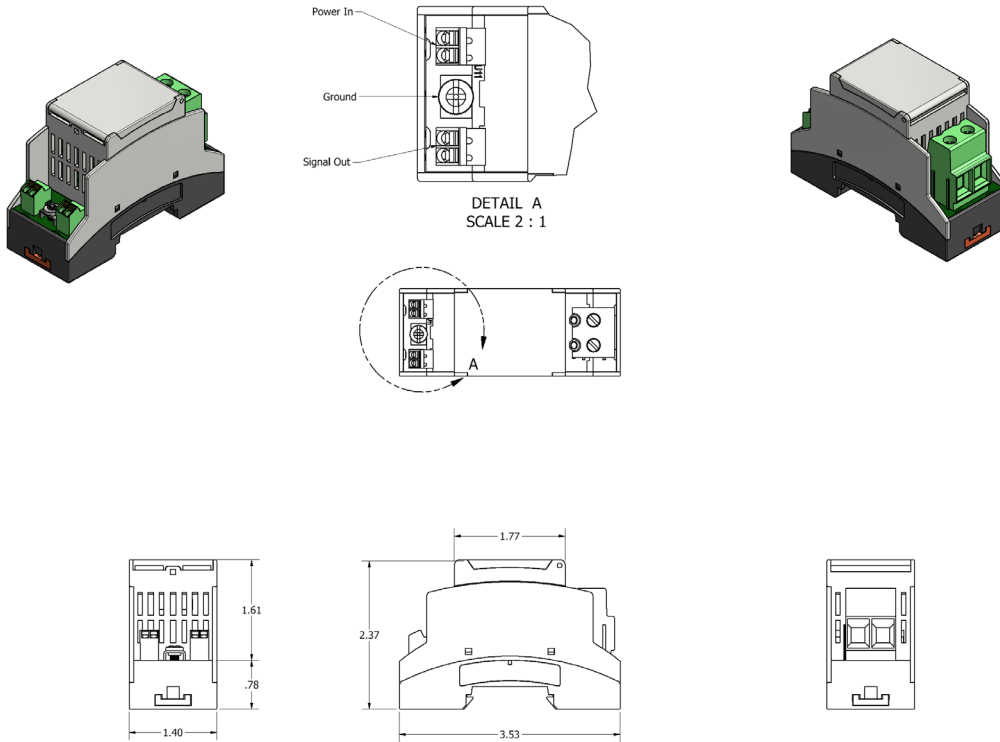

HARDWARE CONFIGURATION

A. Connect external power source to power the unit. For proper functioning the power supply should provide a voltage as specified with at least 0.2A of continuous current and 0.4A surge during module start-up.

B. Securely connect one end of a twisted pair to the output terminals, and the other end to the inputs of your data acquisition unit

C. Pass conductor through aperture and observe orientation for proper signal polarity.

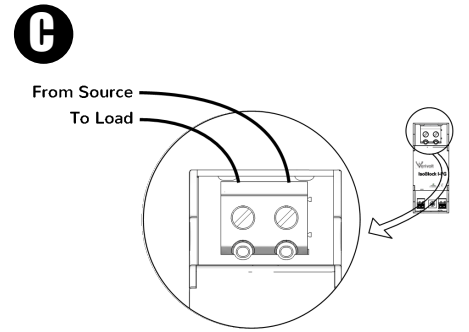
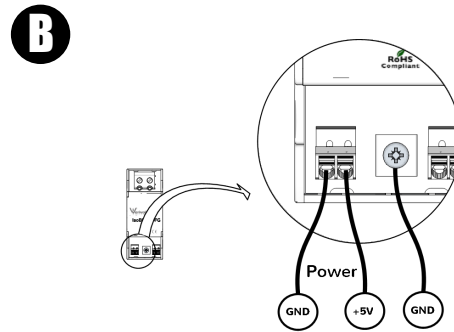
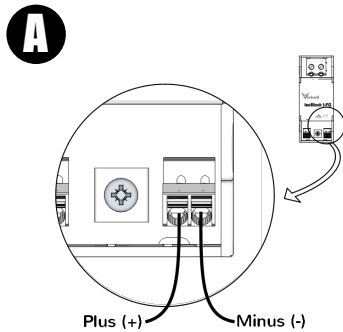

Standards and Certifications

- CE
- RoHS Compliant



THIS SENSOR IS NOT A SAFETY DEVICE AND IS NOT INTENDED TO BE USED AS A SAFETY DEVICE. This sensor is designed only to detect and read certain data in an electronic manner and perform no use apart from that, specifically no safety-related use. This sensor product does not include self-checking redundant circuitry, and the failure of this sensor product could cause either an energized or de-energized output condition, which could result in death, serious bodily injury, or property damage.